



## Flowmeter/Threshold detector with paddle wheel

- Indication, monitoring, transmitting and On/Off control in one device
- Freely adjustable outputs (transistor or relay)
- Automatic calibration using Teach-In
- Process value output: 4...20 mA
- Flow threshold detector

Product variants described in the data sheet may differ from the product presentation and description.

### Can be combined with



**Type 8792** ▶  
Digital electropneumatic Positioner SideControl



**Type 2300** ▶  
Pneumatically operated 2 way angle seat control valve ELEMENT



**Type 8644** ▶  
Remote Process Actuation Control System AirLINE

### Type description

This flowmeter/threshold detector with display is designed for use in clear, neutral or aggressive liquids. The switching outputs enable the direct switching of valves and the establishment of a simple On/Off control circuit within a monitoring system. The switching points can be configured with the 3 keys directly at the display.

The 8032 measuring device (SE32 transmitter + S030 Inline sensor-fitting) is available with freely configurable switching outputs (transistor or relay) or with 4...20 mA process value output.

The transmitter can be fitted to the Inline sensor-fitting via a bayonet catch without having to open the pipeline.

## Table of contents

<b>1. General technical data</b>	<b>3</b>
<hr/>	
<b>2. Approvals</b>	<b>5</b>
2.1. Certification UL.....	5
2.2. Pressure Equipment Directive.....	5
Device used on a pipe.....	5
<hr/>	
<b>3. Materials</b>	<b>6</b>
3.1. Chemical Resistance Chart – Bürkert resistApp.....	6
3.2. Material specifications.....	6
<hr/>	
<b>4. Dimensions</b>	<b>7</b>
4.1. Transmitter SE32.....	7
With cable plug (EN 175301-803).....	7
With Cable plug (EN 175301-803) and free positionable 5 pin M12 male fixed plug.....	7
With cable plug (EN 175301-803) and 8 pin M12 male fixed plug.....	8
4.2. Transmitter SE32 mounted in a S030 sensor-fitting.....	8
<hr/>	
<b>5. Product installation</b>	<b>9</b>
5.1. Installation notes.....	9
<hr/>	
<b>6. Product operation</b>	<b>9</b>
6.1. Measuring principle.....	9
6.2. Functional overview.....	10
6.3. Function modes.....	11
Flow threshold detector.....	11
Type 8032/SE32 with standard On/Off output.....	11
Type 8032/SE32 with current output for the measurement value.....	11
<hr/>	
<b>7. Product design and assembly</b>	<b>11</b>
7.1. Product assembly.....	11
<hr/>	
<b>8. Networking and combination with other Bürkert products</b>	<b>12</b>
<hr/>	
<b>9. Ordering information</b>	<b>12</b>
9.1. Bürkert eShop – Easy ordering and quick delivery.....	12
9.2. Recommendation regarding product selection.....	12
9.3. Bürkert product filter.....	13
9.4. Ordering chart.....	13
9.5. Ordering chart accessories.....	13

## 1. General technical data

### Note:

If the device is mounted in a humid environment or outside, then the maximum voltage allowed is **35 V DC** instead of 36 V DC.

### Product properties

#### Materials

Please make sure the device materials are compatible with the fluid you are using.

Detailed information can be found in chapter **"3.1. Chemical Resistance Chart – Bürkert resistApp"** on page 6.

#### Non wetted parts

Housing, cover	PC, glass fibre reinforced
Front panel folio	Polyester
Screws	Stainless steel
Female cable plug/male fixed plug	PA
M12 male fixed plug	PA or PA and CuZn, nickel-plated

#### Wetted parts

Sensor-fitting body, sensor armature	Brass, stainless steel, PVC, PP or PVDF (depending on S030 version)
Seal	FKM or EPDM (depending on S030 version)
Axis and bearings	Ceramics (Al <sub>2</sub> O <sub>3</sub> )
Paddle wheel	PVDF
Compatibility	Any pipe from DN06...DN65 which are fitted with Bürkert S030 Inline sensor-fitting. For the selection of the nominal diameter of the Inline sensor-fittings, see <b>data sheet Type S030</b> ▶.
Display	8-digit LCD with backlighting
Pipe diameter	DN06...DN65.
Voltage supply cable	Max. 100 m length, shielded <ul style="list-style-type: none"> <li>For female cable plug (supplied): external diameter of wire: 6...7 mm, cross section of wires: 0.14...0.5 mm<sup>2</sup></li> <li>For 5-pins M12 female plug (not supplied): external diameter of wire: 3...6.5 mm, cross section of wires: max. 0.75 mm<sup>2</sup></li> <li>For 8-pins M12 female plug (not supplied): external diameter of wire: 5.9 mm, cross section of wires: 0.25 mm<sup>2</sup></li> </ul>

### Electrical data

Power supply	12...36 V DC ± 10 %, filtered and regulated Connection to main supply: permanent (through external SELV (Safety Extra Low Voltage) and LPS (Limited Power Source) power supply)
Power Source (not supplied)	Limited power source according to UL/EN 60950-1 standards or limited energy circuit according to UL/EN 61010-1 §9.4
Protection against DC polarity reversal	Yes
Current consumption	≤ 80 mA (no load)

### Output signal

Transistor	NPN and/or PNP, open collector <ul style="list-style-type: none"> <li>700 mA max. (500 mA max. per transistor if both transistor outputs are wired)</li> <li>0...300 Hz</li> <li>Operation and thresholds can be parametered</li> <li>NPN-output: 0.2...36 V DC</li> <li>PNP-output: power supply</li> <li>Protection against short circuits</li> </ul>
Relay	Non UL device: <ul style="list-style-type: none"> <li>single relay output: 250 V AC/3 A or 30 V DC/3 A, operation and thresholds can be parametered</li> <li>relay output and 4...20 mA current output: 48 V AC/3 A or 30 V DC/3 A, operation and thresholds can be parametered</li> </ul> UL device: <ul style="list-style-type: none"> <li>30 V AC/42 V<sub>peak</sub>/3 A or 60 V DC/1 A, operation and thresholds can be parametered</li> </ul>

Process value	4...20 mA, galvanic insulation <ul style="list-style-type: none"> <li>• Loop impedance max.: 1300 Ω at 36 V DC, 1000 Ω at 30 V DC, 700 Ω at 24 V DC, 450 Ω at 18 V DC, 200 Ω at 12 V DC</li> <li>• Response time (10...90 %): 3 s with filter 2 (default setting)</li> </ul>
---------------	--

#### Performance data

Measuring range	0.3...10 m/s
Measurement deviation	Teach-In: ± 1 % of the measured value <sup>1.)</sup> (at Teach-In flow rate value) Standard K-factor: ± 3 % of the measured value <sup>1.)</sup>
Linearity	± 0.5 % of full scale <sup>1.)</sup>
Repeatability	± 0.4 % of the measured value <sup>1.)</sup>
4...20 mA output uncertainty	± 0.5 % of range
Operating mode	Threshold: window or hysteresis

#### Medium data

Fluid temperature	With sensor-fitting in: PVC: 0...+50 °C (+32...+122 °F) PP: 0...+80 °C (+32...+176 °F) PVDF, stainless steel or brass: -15...+100 °C (+5...+212 °F)
Fluid pressure (max.)	PN10 with plastic sensor-fitting PN16 (PN40 on request) with metal sensor-fitting Detailed information can be found in the data sheet of the Inline sensor-fittings, see <b>data sheet Type S030</b> ▶ for more information.
Viscosity	300 cSt max.
Rate of solid particles	1 % max. (particle size 0.5 mm max.)

#### Approvals and Certificates

##### Standards

Protection class according to IEC/EN 60529	IP65 with device wired and plugs mounted and tightened or sealed
--	--

##### Directives

CE directives	The applied standards, which verify conformity with the EU Directives, can be found on the EU Type Examination Certificate and/or the EU Declaration of conformity (if applicable)
Pressure equipment directives	Complying with Article 4, Paragraph 1 of 2014/68/EU directive Detailed information on the pressure equipment directive can be found in chapter " <b>2.2. Pressure Equipment Directive</b> " on page 5.
Certification	UL-Recognized for US and Canada

#### Product connections

Process connection	Metal: Internal or external thread, weld ends, Clamp or flange Plastic: True union, spigot or external thread See <b>data sheet Type S030</b> ▶ for more information.
Electrical connections	Cable plug acc. to EN 175301-803, free positionable 5 pin M12 male fixed plug or 8 pin M12 male fixed plug

#### Environment and installation

Ambient temperature	- 10...+60 °C (+ 14...+140 °F) (operation and storage)
Relative air humidity	≤ 80 %, without condensation
Height above sea level	Max. 2000 m
Operating condition	Continuous
Equipment mobility	Fixed
Use	Indoor and outdoor (Protect the device against electromagnetic interference, ultraviolet rays and, when installed outdoors, against the effects of climatic conditions)
Installation category	Category I according to UL/EN 61010-1
Pollution degree	Degree 2 according to UL/EN 61010-1

1.) Under reference conditions i.e. measuring fluid = water, ambient and water temperature = 20 °C (68 °F), while maintaining the minimum inlet and outlet distances and the appropriate internal diameters of the pipes.

## 2. Approvals

### 2.1. Certification UL

Certificate	Description
	<b>UL-Recognized for USA and Canada</b> Products are UL-certified products and comply also with the following standards: <ul style="list-style-type: none"> <li>• UL 61010-1</li> <li>• CAN/CSA-C22.2 No.61010-1</li> </ul>

### 2.2. Pressure Equipment Directive

The device conforms to Article 4, Paragraph 1 of the Pressure Equipment Directive 2014/68/EU under the following conditions:

#### Device used on a pipe

##### Note:

- The data in the table is independent of the chemical compatibility of the material and the fluid.
- PS = maximum admissible pressure; DN = nominal diameter of the pipe

Type of fluid	Conditions
Fluid group 1, Article 4, Paragraph 1.c.i	DN $\leq$ 25
Fluid group 2, Article 4, Paragraph 1.c.i	DN $\leq$ 32 or PS*DN $\leq$ 1000
Fluid group 1, Article 4, Paragraph 1.c.ii	DN $\leq$ 25 or PS*DN $\leq$ 2000
Fluid group 2, Article 4, Paragraph 1.c.ii	DN $\leq$ 200 or PS $\leq$ 10 or PS*DN $\leq$ 5000

### 3. Materials

#### 3.1. Chemical Resistance Chart – Bürkert resistApp

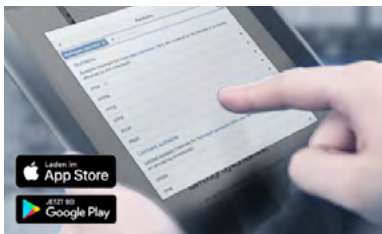

**Bürkert resistApp – Chemical Resistance Chart**

You want to ensure the reliability and durability of the materials in your individual application case? Verify your combination of media and materials on our website or in our resistApp.

[Start Chemical Resistance Check](#)

#### 3.2. Material specifications

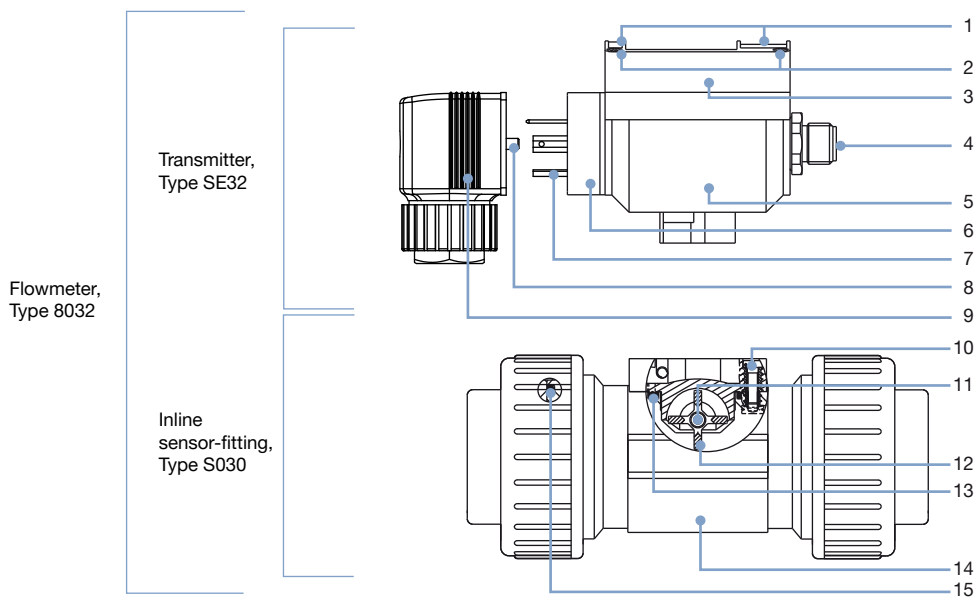

No.	Description	Material
1	Front panel folio	Polyester
2	Screws	Stainless steel
3	Cover	PC, glass fibre reinforced
4	M12 male fixed plug	PA (5 pin), PA and CuZn nickel-plated (8 pin)
5	Housing	PC, glass fibre reinforced
6	Male fixed plug (EN 175301-803)	PA
7	Electrical contact	Sn
8	Screw	Stainless steel
9	Female cable plug (EN 175301-803)	PA
10	Screws	Stainless steel
11	Axis and bearings	Ceramics (Al <sub>2</sub> O <sub>3</sub> )
12	Paddle wheel	PVDF
13	Seal	FKM or EPDM (depending on S030 version)
14	Sensor-fitting body	Stainless steel (316L - 1.4404), brass (CuZn <sub>39</sub> Pb <sub>2</sub> ), PVC, PP, PVDF (depending on S030 version)
15	Seals	FKM or EPDM (depending on S030 version and only for true union connection)

DTS 1000011084 EN Version: S Status: RL (released | freigegeben | valide) printed: 14.06.2019

## 4. Dimensions

### 4.1. Transmitter SE32

With cable plug (EN 175301-803)

**Note:**

Specifications in mm

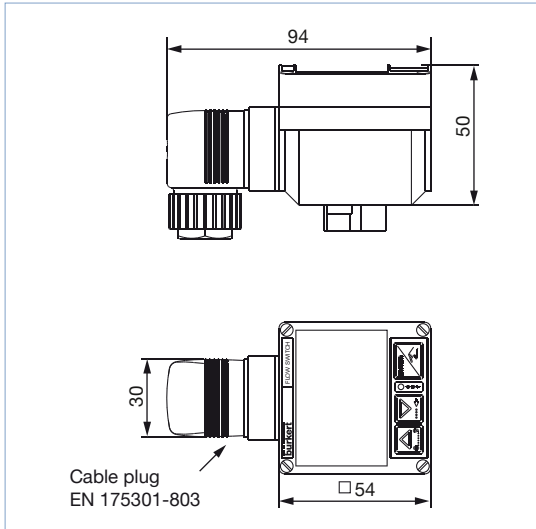

With Cable plug (EN 175301-803) and free positionable 5 pin M12 male fixed plug

**Note:**

Specifications in mm

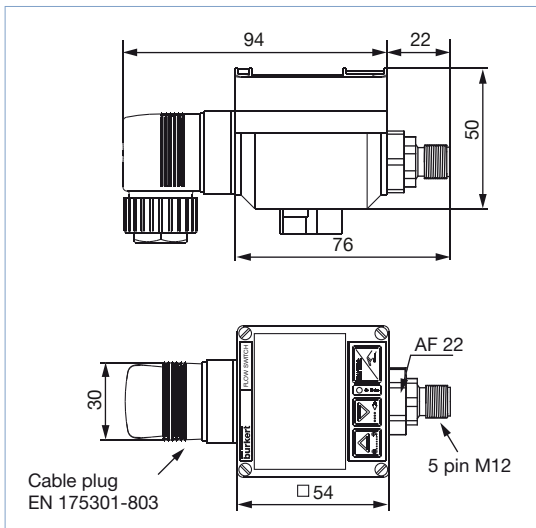

With cable plug (EN 175301-803) and 8 pin M12 male fixed plug

**Note:**  
Specifications in mm

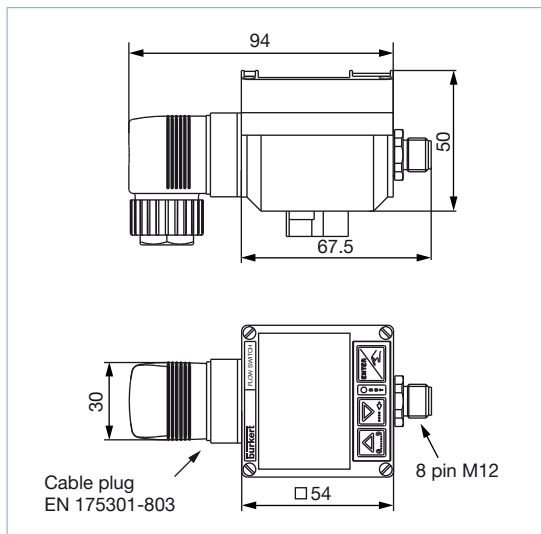

#### 4.2. Transmitter SE32 mounted in a S030 sensor-fitting

**Note:**  
Specifications in mm

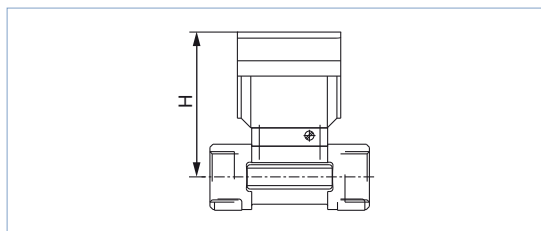

DN	H
06	79.5
08	79.5
15	84.5
20	82.0
25	82.2
32	85.8
40	89.6
50	95.7
65	95.7



## 5. Product installation

### 5.1. Installation notes

**Note:**

The flowmeter is not designed for gas and steam flow measurement.

Minimum straight upstream and downstream distances must be observed. According to the pipe's design, necessary distances can be bigger or use a flow conditioner to obtain the best accuracy.

For more information, please refer to EN ISO 5167-1.

EN ISO 5167-1 prescribes the straight inlet and outlet distances that must be complied with when installing fittings in pipe lines in order to achieve calm flow conditions. The most important layouts that could lead to turbulence in the flow are shown below, together with the associated prescribed minimum inlet and outlet distances.

Make sure that the measuring conditions at the point of measurement are calm and problem-free.

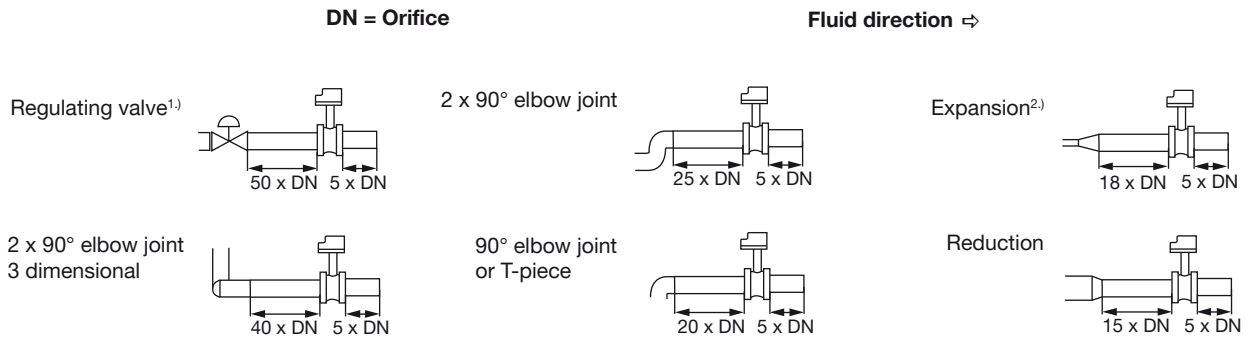

1.) If the valve cannot be mounted after the measuring device, the minimal distances have to be respected.

2.) If an expansion cannot be avoided, the minimal distances have to be respected.  
Please note minimum flow velocity

The flowmeter can be installed into either horizontal or vertical pipes.

Important criteria for this are; ensure that the measurement pipe is fully filled and that the measurement pipe is air bubble free.

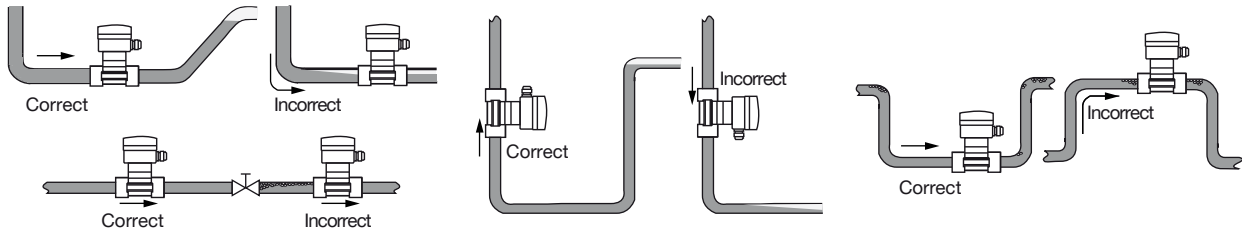

Pressure and temperature ratings must be respected according to the selected sensor-fitting material. The suitable pipe size is selected using the diagram for selecting the nominal diameter of the sensor-fitting, see **data sheet Type S030** ▶ for more information.

## 6. Product operation

### 6.1. Measuring principle

When liquid flows through the pipe, the paddle wheel with 4 inserted magnets is set in rotation, producing a measuring signal in the sensor (Hall sensor). The frequency modulated induced voltage is proportional to the flow velocity of the fluid.

A K-factor (available in the instruction manual of the S030 sensor-fitting), specific to each pipe (size and material) enables the conversion of this frequency into a flow rate.

The electrical connection is provided via a cable plug according to EN 175301-803 and/or a M12 multipin plug.

## 6.2. Functional overview

The display is used to:

- read the value of certain parameters such as the measured flow rate
- parameterize the device by means of 3 keys
- read the configuration of the device
- get notification of some events.

Display and operating keys	No.	Description
	1	Shows if the relay is open or closed
	2	Means that the access to the Parameters and Test menus is protected through a code
	3	Bar graph is running in each mode, except during a Teach-In procedure
	4	“Confirm” key: <ul style="list-style-type: none"> <li>• to confirm the function displayed</li> <li>• to confirm the parameters set</li> </ul>
	5	Shows the status of the on/off output (red LED)
	6	“Next” key: <ul style="list-style-type: none"> <li>• to select the digit at the left</li> <li>• to go to the next function</li> </ul>
	7	“Back” key: <ul style="list-style-type: none"> <li>• to change the value (0...9) of the selected digit</li> <li>• to go back to the previous function</li> </ul>

The device can be calibrated by means of the K-factor (conversion coefficient), or via the Teach-In function. User adjustments, such as engineering units, output, filter, bargraph are carried out on site.

The device has 2 operating levels:

- the Process level
- the Configuration level, which comprises the Parameters and the Test menus

Operating level	Functions
Process	<ul style="list-style-type: none"> <li>• Indication of                             <ul style="list-style-type: none"> <li>– the value of the measured flow rate</li> <li>– switching thresholds (high and low value)</li> <li>– the value of the 4...20 mA output (flowmeter only)</li> </ul> </li> <li>• Access to the Parameters and Test menus of the Configuration level</li> </ul>
Configuration - Parameters menu	<ul style="list-style-type: none"> <li>• To make the settings needed for operation:                             <ul style="list-style-type: none"> <li>– engineering units (International measuring units)</li> <li>– K-factor/Teach-In function</li> <li>– 4...20-mA-current output (flowmeter only)</li> <li>– selection of switching mode: window, hysteresis (see chapter “6.3. Function modes” on page 11.)</li> <li>– selection of threshold value (see chapter “6.3. Function modes” on page 11.)</li> <li>– delay</li> <li>– filter</li> <li>– 10-segment bargraph (select min. and max. value)</li> </ul> </li> <li>• Additional parameter definition                             <ul style="list-style-type: none"> <li>– backlighting</li> <li>– Password protects the access to the Parameters and Test menus</li> </ul> </li> </ul>
Configuration - Test menu	<ul style="list-style-type: none"> <li>• To test the configuration made in the Parameters menu with entering of a theoretical value</li> <li>• To read the frequency of the measured signal</li> <li>• To adjust the 4...20 mA current output</li> </ul>

DTS 1000011084 EN Version: S Status: RL (released | freigegeben | valide) printed: 14.06.2019

### 6.3. Function modes

#### Flow threshold detector

##### Type 8032/SE32 with standard On/Off output

- 2 switching modes for the output, either hysteresis or window, inverted or not

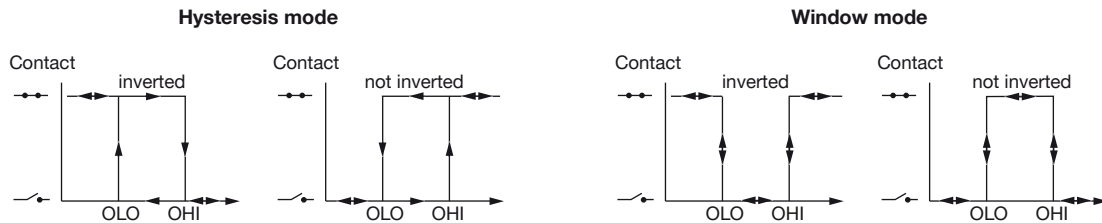

- Configurable delay before switching
- Possible outputs depending on the version: relay, transistor NPN, transistor PNP

##### Type 8032/SE32 with current output for the measurement value

- 4...20 mA output
- 4...20 mA output + relay output

## 7. Product design and assembly

### 7.1. Product assembly

#### Note:

- The 8032 device is made up of a compact Inline sensor-fitting (S030) equipped with a sensor with paddle wheel and a transmitter (SE32).
- The S030 Inline sensor-fitting ensures simple installation into pipes from DN06...DN65. The SE32 transmitter can easily be installed into any Bürkert sensor-fitting system, by means of a quarter turn.

See [Data sheet Type S030](#) ▶ for more information.

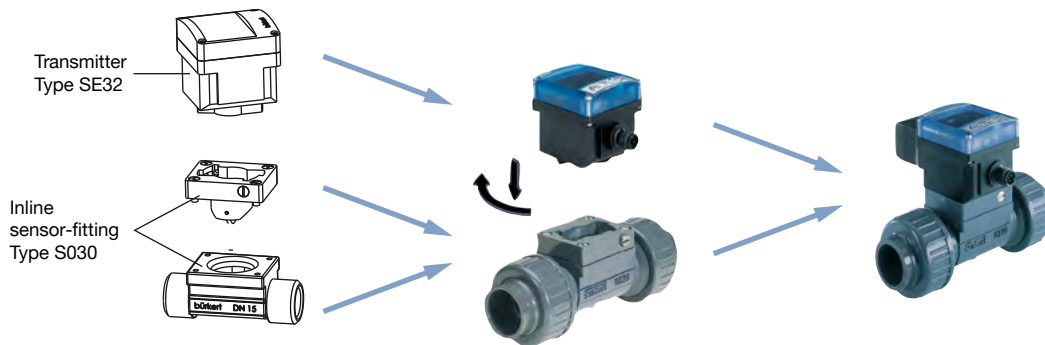

## 8. Networking and combination with other Bürkert products

Example:

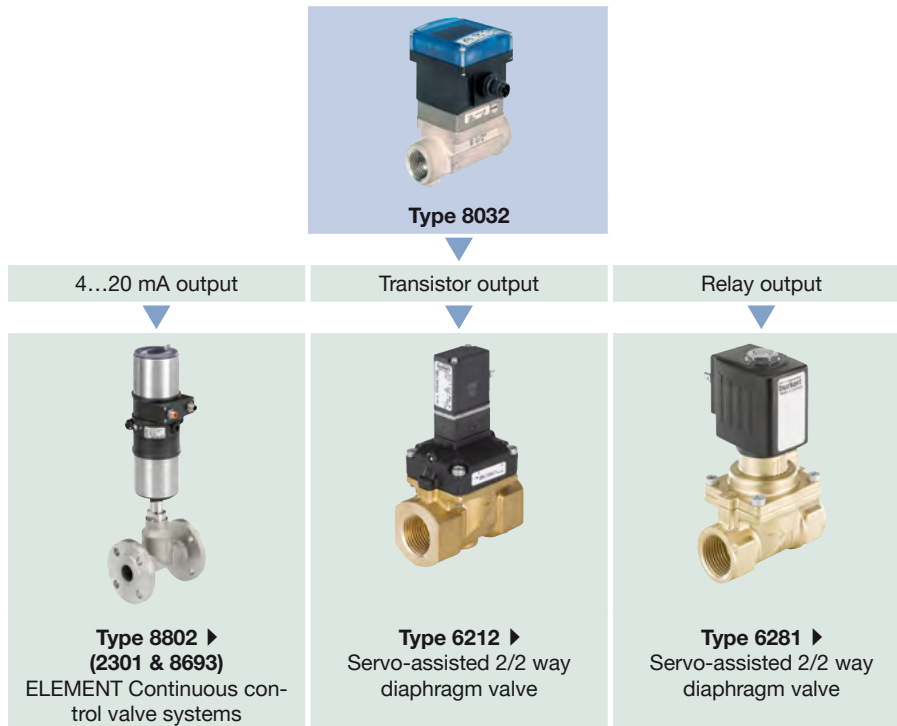

## 9. Ordering information

### 9.1. Bürkert eShop – Easy ordering and quick delivery



**Bürkert eShop – Easy ordering and fast delivery**

You want to find your desired Bürkert product or spare part quickly and order directly? Our online shop is available for you 24/7. Sign up and enjoy all the benefits.

[Order online now](#)

### 9.2. Recommendation regarding product selection

A complete 8032 flowmeter/threshold detector consists of a compact SE32 flow transmitter and a Bürkert S030 Inline sensor-fitting.

See **Data sheet Type S030** ▶ for more information.

Two different components must be ordered in order to select a complete device. The following information is required:

- **Article no.** of the desired compact SE32 flow transmitter (see chapter “**9.4. Ordering chart**” on page 13)
- **Article no.** of the selected S030 Inline sensor-fitting (See **Data sheet Type S030** ▶)

### 9.3. Bürkert product filter











#### Bürkert product filter – Get quickly to the right product

You want to select products comfortably based on your technical requirements? Use the Bürkert product filter and find suitable articles for your application quickly and easily.







[Try out our product filter](#)

### 9.4. Ordering chart

Voltage supply	Output	UL certification	Electrical connection	Article no.
<b>Flow threshold detector Type SE32</b>				
12...36 V DC	1 x transistor NPN	No	Female cable plug EN 175301-803 <sup>1.)</sup>	436474 
	1 x transistor PNP	No	Female cable plug EN 175301-803 <sup>1.)</sup>	434871 
	2 x transistors NPN/PNP	No	Free positionable 5 pin M12 male fixed plug	436473 
		UL-Recognized	Free positionable 5 pin M12 male fixed plug	553431 
	Relay	No	Free positionable 5 pin M12 male fixed plug and female cable plug EN 175301-803 <sup>1.)</sup>	436475 
<b>Flow transmitter Type SE32</b>				
12...36 V DC	4...20 mA + relay	No	8 pin M12 male fixed plug and female cable plug EN 175301-803 <sup>1.)</sup>	560547 
		No	Free positionable 5 pin M12 male fixed plug and female cable plug EN 175301-803 <sup>1.)</sup>	560402 
	4...20 mA	No	Free positionable 5 pin M12 male fixed plug	560403 

1.) Europe/Asia (G/Rc): M16 x 1.5 mm cable plug  
USA/CDN (NPT): NPT 1/2" cable plug

### 9.5. Ordering chart accessories

Description	Article no.
5 pin M12 female straight cable plug with plastic threaded locking ring, to be wired	917116 
5 pin M12 female straight cable plug moulded on cable (2 m, shielded)	438680 
8 pin M12 female straight cable plug with plastic threaded locking ring, to be wired	444799 
8 pin M12 female straight cable plug moulded on cable (2 m, shielded)	444800 
Female cable plug EN 175301-803 with cable gland - see <b>Type 2508</b> ▶ (will be replaced with Type 2518)	438811 
Female cable plug EN 175301-803 with NPT 1/2" reduction without cable gland - see <b>Type 2509</b> ▶	162673 

# Bürkert – Close to You

For up-to-date addresses  
please visit us at  
[www.burkert.com](http://www.burkert.com)

DTS 1000011084 EN Version: S Status: RL (released | freigegeben | validé) printed: 14.06.2019

